



2012



- NL** PRIJSLIJST STRAAT- en PARKMEUBILAIR
- F** TARIF MOBILIER URBAIN
- D** PREISLISTE STADT- und PARKMOBILIAR
- UK** PRICE-LIST STREET- and PARKFURNITURE

NL

Voorwaarden

- Prijzen in Euro, exclusief BTW.
- Af fabriek Alken/Opglabbeek.
- Algemene voorwaarden in bijlage, van toepassing op elke levering.
- Tussentijdse prijswijzigingen voorbehouden.
- Met deze prijslijst vervallen alle voorgaande prijzen.
- Bij de kleuren beige en grijs is de kans op kleurafwijkingen groter.
- Onder voorbehoud van drukfouten.
- Minimum bestelbedrag 250 €.

F

Conditions

- Prix en Euro hors TVA.
- Prix départ usine Alken/Opglabbeek.
- Conditions générales en annexe, applicables à chaque livraison.
- Sous réserve de modifications intermédiaires des prix.
- Ce tarif remplace tous les tarifs antérieurs.
- Possibilité plus élevée d'anomalies légères de couleur pour le beige et le gris.
- Sous réserve de fautes d'impression.
- Montant minimum de la commande 250 €.

D

Bedingungen

- Preise in Euro ohne MwSt.
- Preise ab Lager Alken/Opglabbeek.
- Allgemeine Verkaufsbedingungen in Anlage, gültig für alle Lieferungen.
- Zwischenzeitliche Preisänderungen vorbehalten.
- Mit diesen Preisen, verlieren alle vorherigen Preisen ihre Gültigkeit.
- Größere Möglichkeit auf leichte Abweichungen in Farbe für beige und grau.
- Unter Vorbehalt von Druckfehler.
- Mindestbestellbetrag 250 €.

UK

Conditions

- Prices in Euro excluding VAT.
- Ex works Alken/Opglabbeek.
- General sales conditions enclosed, valid for all deliveries.
- Subject to interim price changes.
- These prices replace all previous prices.
- Larger possibility of slight colour differences for beige and grey.
- Under reservation of printing errors.
- Minimum order amount 250 €.

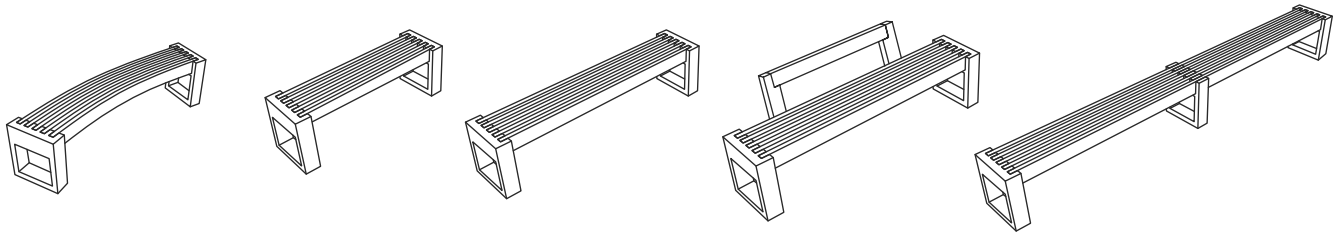

CANVAS 30°

CANVAS 120

CANVAS 180

CANVAS 180 ML

CANVAS 360

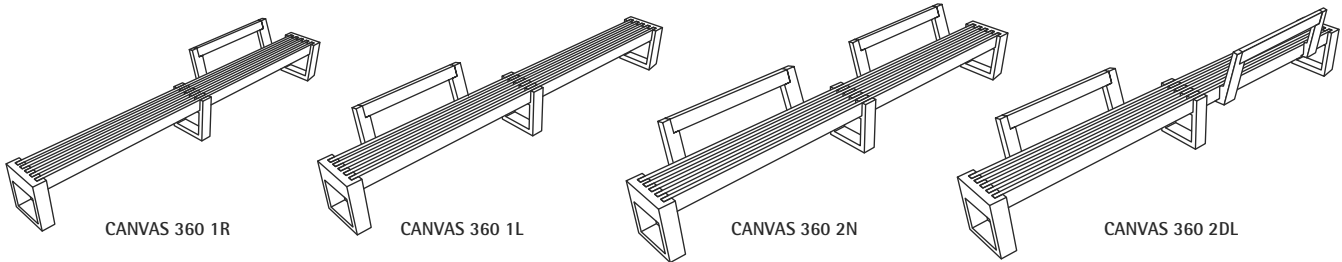

CANVAS 360 1R

CANVAS 360 1L

CANVAS 360 2N

CANVAS 360 2DL

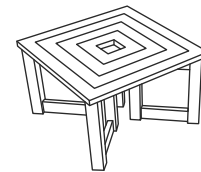

nieuw
nouveau
neu
new

CANVAS T 120

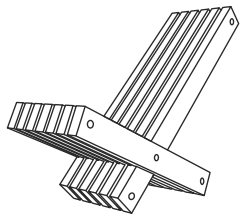

ATLANTIC

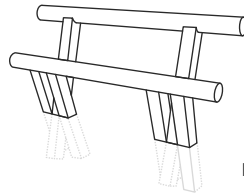

Level X

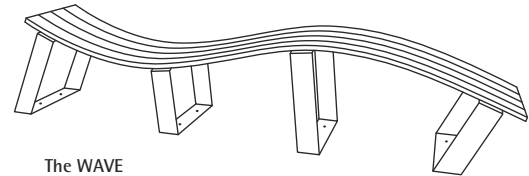

The WAVE

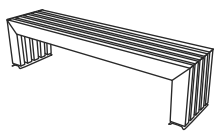

AVENUE

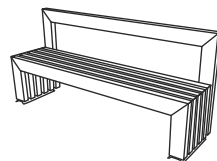

BOULEVARD

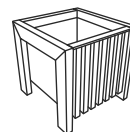

PLAZA

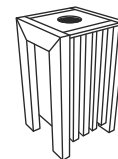

SQUARE

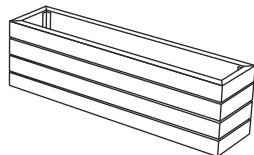

AGORA

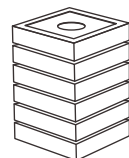

AGORA

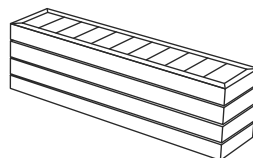

AGORA

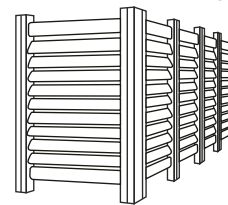

NORMANDIE

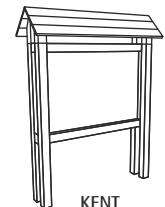

KENT

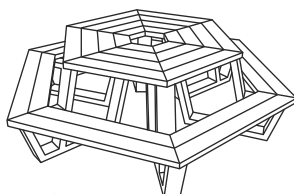

ROMA

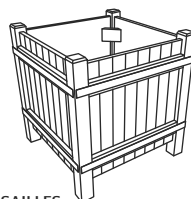

VERSAILLES

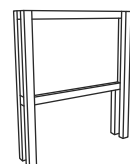
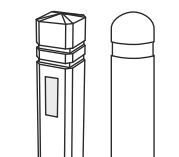

KENT

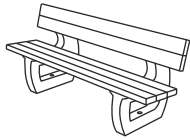

BONN ML

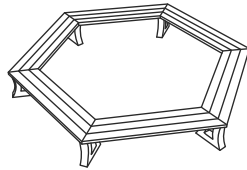

BONN 360°

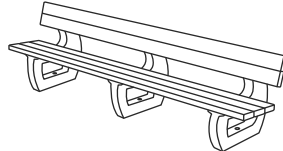

BONN ML 360cm

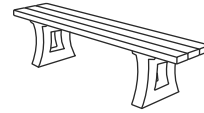

BONN ZL

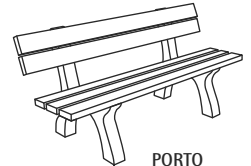

PORTO

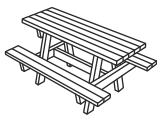

OSLO junior

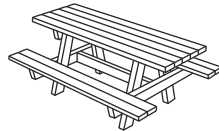

OSLO

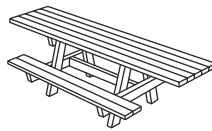

OSLO XL

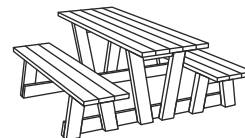

LYON ZL

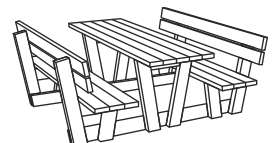

LYON ML



LONDON ZL



LONDON ML 360 cm

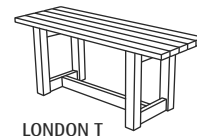

LONDON T

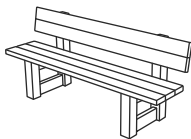

LONDON ML

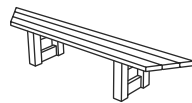

LONDON 60°

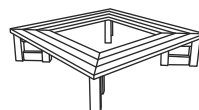

LONDON 4ZL

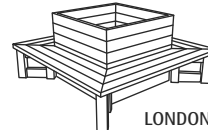

LONDON 4B

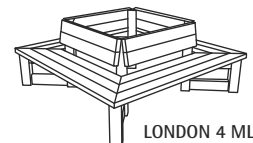

LONDON 4 ML

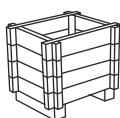

BERLIN

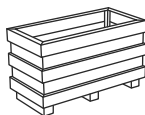

MADRID

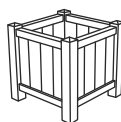

PALMA

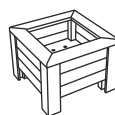

MILANO



BARCELONA



VIENNA



NAPOLI

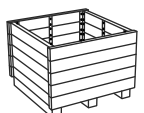

ROTTERDAM



WINDSOR

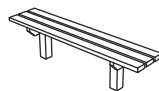

SOFIA

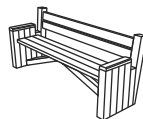

PALERMO

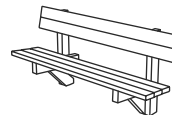

PARIS

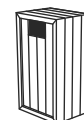

JUPITER



MERCURE

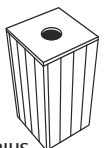

SIRIUS

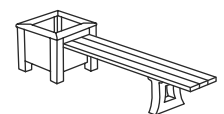
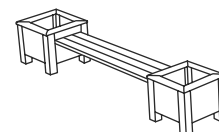
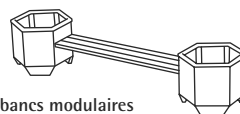
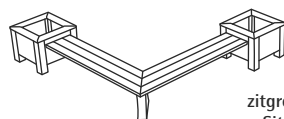
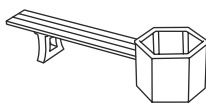

zitgroepen / bancs modulaires
Sitzgruppe / seating areas

Banken CANVAS voeten steeds zwart
Bancs CANVAS pieds toujours noirs
Bänke CANVAS Füße immer schwarz
Benches CANVAS legs always black

prijs / st.
prix / pc.
Preis / St.
price / pc.

1 verankeringpunt CANVAS
(tel het aantal verankeringpunten !)
aanbevolen optie p.19
één verankeringset per verankeringpunt

1 point d'ancrage CANVAS
(comptez le nombre de points d'ancrage !)
option recommandée p.19
un set d'ancrage par point d'ancrage

1 Verankerungspunkt CANVAS
(zählen Sie die Verankerungspunkte !)
empfohlene Option p.19
ein Verankerungssatz pro Verankerungspunkt

1 anchorage point CANVAS
(count the anchorage points !)
recommended option p.19
one anchorage set per anchorage point

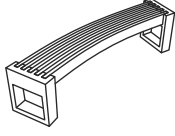
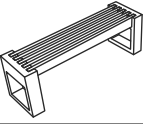
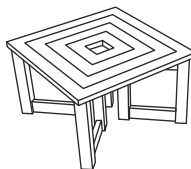
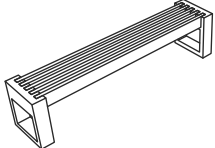
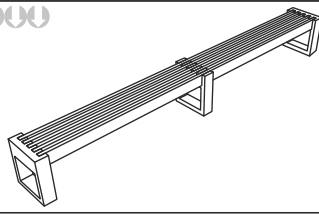
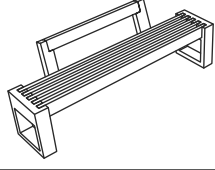
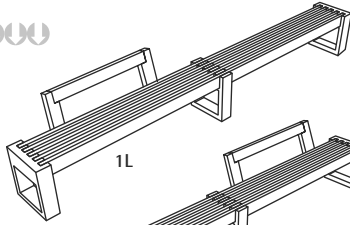
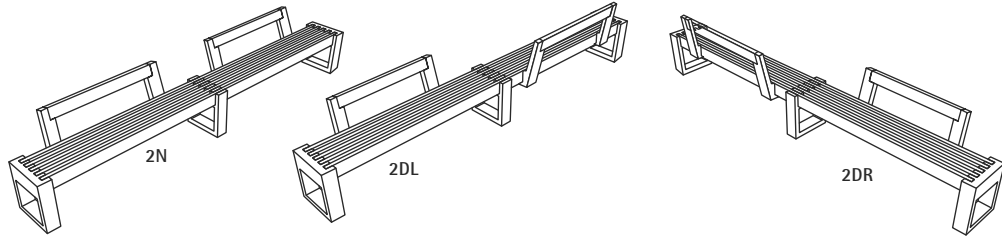
beschrijving description Beschreibung description	afm. (cm) dim. (cm) Abm. (cm) dim. (cm)	gewicht poids Gewicht weight	grijs of zwart gris ou noir grau oder schwarz grey or black	bruin brun braun brown	beige beige beige beige	
CANVAS 30°	190 x 45 x 45	61 kg	346 €	349 €	367 €	
CANVAS 120	132 x 40 x 45	49 kg	272 €	274 €	287 €	
CANVAS T120	120 x 120	110 kg	593 €	603 €	654 €	
CANVAS 180	192 x 40 x 45	60 kg	292 €	296 €	314 €	
CANVAS 360	372 x 40 x 45	107 kg	494 €	501 €	537 €	
CANVAS 180 ML	192 x 80 x 60	74 kg	442 €	447 €	469 €	
CANVAS 360 1L / 1R	372 x 40 x 45	120 kg	643 €	652 €	692 €	
CANVAS 360 2N / 2DL / 2DR	372 x 40 x 45	133 kg	785 €	793 €	836 €	

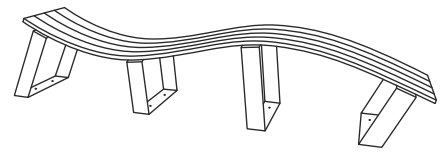
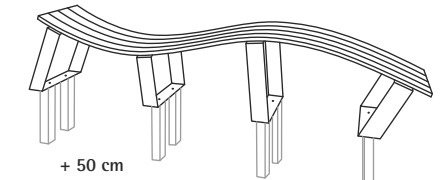
banken bancs Bänke benches			The WAVE			prijs / st. prix / pc. Preis / St. price / pc.			<p>Steeds te verankeren ! Verankerung inbegrepen. Toujours à ancrer ! Ancrage inclus. Immer zu verankeren ! Verankerung einbegriffen. Always to be anchored ! Anchorage included.</p>   <p>+ 50 cm 8 kunststof verlengstukken voor grondverankerung + bouten 8 rallonges en plastique pour ancrage + boulons 8 Verlängerungsstücke für Verankerung + Bolzen 8 extensions for anchorage + bolts</p>
beschrijving description Beschreibung description	afm. (cm) dim. (cm) Abm. (cm) dim. (cm)	gewicht poids Gewicht weight	grijs of zwart gris ou noir grau oder schwarz grey or black	bruin brun braun brown	beige beige beige beige				
The WAVE met gegalvaniseerde poten avec pieds galvanisés mit galvanisierten Füßen with galvanised legs	382 x 60 x 95	200 kg	2.204 €	2.211 €	2.248 €				
The WAVE met RVS poten avec pieds inox mit Edelstahl Füßen with stainless steel legs			4.379 €	4.386 €	4.423 €				
The WAVE-G met gegalvaniseerde poten avec pieds galvanisés mit galvanisierten Füßen with galvanised legs	382 x 60 x 95	215 kg	2.234 €	2.241 €	2.278 €				
The WAVE-G met RVS poten avec pieds inox mit Edelstahl Füßen with stainless steel legs			4.411 €	4.481 €	4.455 €				

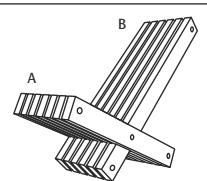
ligstoel chaise longue Liegestuhl deck chair			ATLANTIC			prijs / st. prix / pc. Preis / St. price / pc.			<p>(*) Alle kleurencombinaties A en B: dezelfde prijs (*) Toutes combinaisons couleurs A et B: même prix (*) Alle Farbenkombinationen A und B : derselben preis (*) All colour combinations A and B: same price</p> 
beschrijving description Beschreibung description	afm. (cm) dim. (cm) Abm. (cm) dim. (cm)	gewicht poids Gewicht weight	grijs/zwart/bruin/beige * gris/noir/brun/beige * grau/schwarz/braun/beige* grey/black/brown/beige*						
ATLANTIC	116 x 68 x 45	75 kg	666 €						
<p>Steeds te verankeren ! Verankerung inbegrepen. Toujours à ancrer ! Ancrage inclus. Immer zu verankeren ! Verankerung einbegriffen. Always to be anchored ! Anchorage included.</p>			<p>2 gegalvaniseerde binnenzeskantbouten (DIN912) M12x120 + 2 gegalvaniseerde ringen + 2 hulsankers met binnendraad M12x50 2 vis à six pans creux galvanisés (DIN912) M12x120 + 2 rondelles galvanisées + 2 tiges avec filet intérieur M12x50 2 galvaniseerde Innensechskantschrauben (DIN912) M12x120 + 2 galvaniseerde Ringe + 2 Bolzen mit Innengewinde M12x50 2 galvanized hex socket screws (DIN912) M12x120 + 2 galvanized rings + 2 inner threaded bars M12x50</p>						

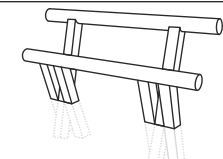
Level X			ronde balken steeds zwart piquets ronds toujours noirs runde Balken immer schwarz round beams always black			prijs / st. prix / pc. Preis / St. price / pc.			<p>De bankvoeten worden ingegraven en verankerd met beton of gestabiliseerd zand. Les pieds sont enterrés et ancrés avec du béton ou sable stabilisé. Die Bankfüße werden eingegraben und mit Beton oder stabilisierten Sand verankert. The bench legs are dug in and anchored with concrete or stabilised sand.</p> 
beschrijving description Beschreibung description	afm. (cm) dim. (cm) Abm. (cm) dim. (cm)	gewicht poids Gewicht weight	voeten grijs pieds gris Füße grau legs grey	voeten zwart pieds noir Füße schwarz legs black	voeten bruin pieds brun Füße braun legs brown				
Level X	180 x 150 x 49	78 kg	391 €	391 €	397 €				

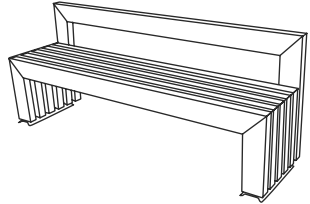
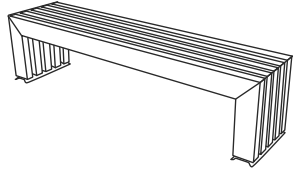
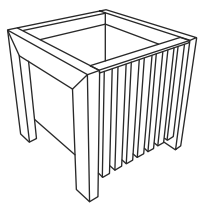
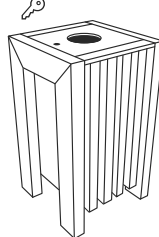
banken, vuilnisbakken en bloembakken bancs, bacs a fleurs et poubelles Bänke, Blumenkäste und Abfallbehälter benches, planters and litter-bins			prijs / st. prix / pc. Preis / St. price / pc.		
beschrijving description Beschreibung description	afm. (cm) dim. (cm) Abm. (cm) dim. (cm)	gewicht poids Gewicht weight	grijs of zwart gris ou noir grau oder schwarz grey or black	bruin of beige brun ou beige braun oder beige brown or beige	
BOULEVARD bank met leuning banc avec dossier Bank mit Lehne bench with back	180 x 49 x 45	112 kg	1.319 €	op aanvraag sur demande auf Anfrage on demand	 Steeds te verankeren ! Verankering inbegrepen. Toujours à ancrer ! Ancrage inclus. Immer zu verankeren ! Verankerung einbegriffen. Always to be anchored ! Anchorage included.
AVENUE bank zonder leuning banc sans dossier Bank ohne Lehne bench without back	180 x 40 x 46	90 kg	1.150 €	op aanvraag sur demande auf Anfrage on demand	 Steeds te verankeren ! Verankering inbegrepen. Toujours à ancrer ! Ancrage inclus. Immer zu verankeren ! Verankerung einbegriffen. Always to be anchored ! Anchorage included.
PLAZA bloembak bac à fleurs Blumenkasten planter	72 x 74 x H71	87 kg	1.584 €	op aanvraag sur demande auf Anfrage on demand	
SQUARE vuilnisbak poubelle Abfallbehälter litter-bin	47 x 50 x H85	80 kg	1.648 € voor plastic zak pour sac en plastique für Plasticbeutel for plastic bag 1.710 € met binnenbak 70 L avec bac intérieur 70 L mit Behälter 70 L with bin 70 L	op aanvraag sur demande auf Anfrage on demand	

alle metalen onderdelen in geborsteld roestvrij staal
toutes les pièces métalliques en acier inoxydable
alle Verbindungselemente sind aus Edelstahl
all metal parts are made of stainless steel



deksel voorzien van ronde opening, slot en sleutel
couvercle avec trou rond, serrure avec clef
Deckel mit runder Öffnung Schloss mit Schlüssel
lid with round hole, lock and key











1 verankeringpunt
(tel het aantal verankeringpunten !)
aanbevolen optie p.19:
één verankeringset per verankeringpunt

1 point d'ancrage
(comptez le nombre de points d'ancrage !)
option recommandée p.19
un set d'ancrage par point d'ancrage

1 Verankerungspunkt
(zählen Sie die Verankerungspunkte !)
empfohlene Option p.19
ein Verankerungssatz pro Verankerungspunkt

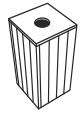
1 anchorage point
(count the anchorage points !)
recommended option p.19
one anchorage set per anchorage point

vuilnisbakken poubelles Abfallbehälter litter-bins			prijs / st. prix / pc. Preis / St. price / pc.					
beschrijving description Beschreibung description	afm. (cm) dim. (cm) Abm. (cm) dim. (cm)	gewicht poids Gewicht weight	grijs of zwart gris ou noir grau oder schwarz grey or black	bruin brun braun brown	groen vert grün green	beige beige beige beige		
AGORA	45 x 45 x 80	69 kg	voor plastic zak / pour sac en plastique / für Plasticbeutel / for plastic bag					
			609 €	615 €		646 €		
			met binnenbak 70 L / avec bac intérieur 70 L / mit Behälter 70 L / with bin 70 L					
MERCURE	53 x 53 x 90	70,5 kg	voor plastic zak / pour sac en plastique / für Plasticbeutel / for plastic bag					
			605 €	611 €	622 €	640 €		
			met binnenbak 70 L / avec bac intérieur 70 L / mit Behälter 70 L / with bin 70 L					
JUPITER	52 x 48 x 90	80 kg	voor plastic zak / pour sac en plastique / für Plasticbeutel / for plastic bag					
			500 €	507 €	520 €	541 €		
			met binnenbak 70 L / avec bac intérieur 70 L / mit Behälter 70 L / with bin 70 L					
SIRIUS	45 x 45 x 80	45 kg	voor plastic zak / pour sac en plastique / für Plasticbeutel / for plastic bag					
			345 €	349 €	358 €	371 €		
			met binnenbak 70 L / avec bac intérieur 70 L / mit Behälter 70 L / with bin 70 L					
optie option Option option		beschrijving description Beschreibung description					prijs prix Preis price	
Bicolor JUPITER		zijkanten zwart, voor- en achterkant grijs, bruin, groen of beige côtés en noir, porte et côté arrière en gris, brun, vert ou beige Seitenflächen sind Schwarz, Vorderseite und Rückseite grau, braun, grün oder beige sides are black, front and back either grey, brown, green or beige					= beige = beige = beige = beige	

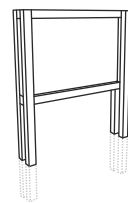
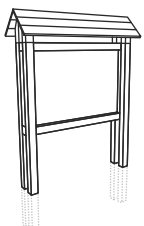
informatieborden KENT panneaux d'information KENT Infotafeln KENT information boards KENT			prijs / st. prix / pc. Preis / St. price / pc.				
beschrijving description Beschreibung description	afm. (cm) dim. (cm) Abm. (cm) dim. (cm)	gewicht poids Gewicht weight	grijs of zwart gris ou noir grau oder schwarz grey or black	bruin brun braun brown	groen vert grün green	beige beige beige beige	
KENT zonder dak sans toit ohne Dach without roof nuttige oppervlakte bord: 95 x 145 cm surface utile du panneau: 95 x 145 cm nützliche Oberfläche: 95 x 145 cm useful surface board: 95 x 145 cm	165 x 30 x H190 h* = 265	145 kg	611 €	626 €	656 €	701 €	
KENT met dak avec toit mit Dach with roof nuttige oppervlakte bord: 95 x 145 cm surface utile du panneau: 95 x 145 cm nützliche Oberfläche: 95 x 145 cm useful surface board: 95 x 145 cm	180 x 60 x H230 h* = 305	188 kg	833 €	855 €	898 €	963 €	

Zitbanken en tafels met metalen versterkingsprofielen onder het zitvlak en het tafelblad.
Bancs et tables avec renforts métalliques au-dessous des assises et tablettes
Bänke und Tische mit metallenen Verstärkungsprofilen unter die Sitzfläche und unter die Tischplatte
Benches and tables reinforced with countersunk galvanised profiles





1 verankeringspunt
(tel het aantal verankeringspunten !)
aanbevolen optie p.19:
één verankeringsset per verankeringspunt

1 point d'ancrage
(comptez le nombre de points d'ancrage !)
option recommandée p.19
un set d'ancrage par point d'ancrage

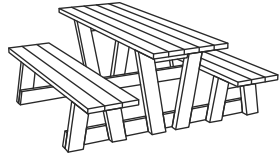

1 Verankerungspunkt
(zählen Sie die Verankerungspunkte !)
empfohlene Option p.19
ein Verankerungssatz pro Verankerungspunkt

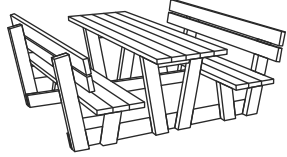
1 anchorage point
(count the anchorage points !)
recommended option p.19
one anchorage set per anchorage point

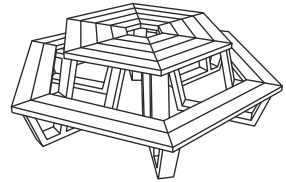
picknicktafels tables pique-nique Picknickbänke picnic tables			prijs / st. prix / pc. Preis / St. price / pc.				
beschrijving description Beschreibung description	afm. (cm) dim. (cm) Abm. (cm) dim. (cm)	gewicht poids Gewicht weight	grijs of zwart gris ou noir grau oder schwarz grey or black	bruin brun braun brown	groen vert grün green	beige beige beige beige	
LYON ZL	180	180 kg	774 €	789 €	818 €	861 €	 
LYON ML	180	230 kg	890 €	908 €	945 €	1000 €	 
ROMA	250 x 250	240 kg	1222 €	1244 €	1287 €	1352 €	 

optie option Option option	beschrijving description Beschreibung description	prijs prix Preis price
Bicolor LYON, ROMA	tafelvoeten altijd zwart, planken grijs, bruin, beige of groen pieds toujours en noir, planches en gris, brun, beige ou en vert Füße immer schwarz, Bretter grau, braun, beige oder grün legs always black, boards either grey, brown, beige or green	= beige = beige = beige = beige









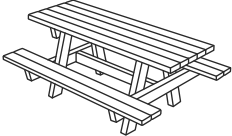

De zitbanken en tafels zijn voorzien van metalen verstevigingsprofielen onder het zitvlak en het tafelblad.
Les bancs et tables sont pourvus de renforts métalliques au-dessous des assises et tablettes
Die Bänke und Tische sind ausgestattet mit metalen Verstärkungsprofilen unter die Sitzfläche und unter die Tischplatte
The benches and tables are reinforced with countersunk galvanised profiles

1 verankeringspunt
(tel het aantal verankeringspunten !)
aanbevolen optie p.19
één verankeringsset per verankeringspunt

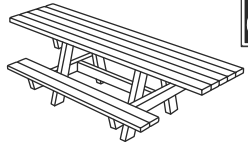
1 point d'ancrage
(comptez le nombre de points d'ancrage !)
option recommandée p.19
un set d'ancrage par point d'ancrage

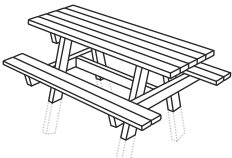
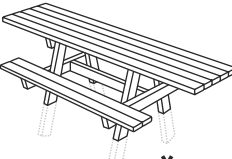
1 Verankerungspunkt
(zählen Sie die Verankerungspunkte !)
empfohlene Option p.19
ein Verankerungssatz pro Verankerungspunkt

1 anchorage point
(count the anchorage points !)
recommended option p.19
one anchorage set per anchorage point

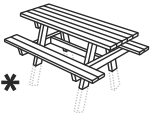
picknicktafels tables pique-nique Picknicktische picnic tables			prijs / st. prix / pc. Preis / St. price / pc.				 =
beschrijving description Beschreibung description	afm. (cm) dim. (cm) Abm. (cm) dim. (cm)	gewicht poids Gewicht weight	grijs of zwart gris ou noir grau oder schwarz grey or black	bruin brun braun brown	groen vert grün green	beige beige beige beige	
OSLO	180	154 kg	603 €	615 €	637 €	670 €	 
OSLO XL	240	180 kg	825 €	840 €	870 €	914 €	  
OSLO-G	180	164 kg	614 €	626 €	650 €	686 €	
OSLO XL-G	240	190 kg	832 €	848 €	879 €	926 €	 
OSLO Junior **	120 H = 55 cm !	83 kg	317 €	324 €	338 €	360 €	 
OSLO-G Junior **	120 H = 55 cm !	89 kg	323 €	331 €	347 €	371 €	

* verlengde poten
pieds prolongés
verlängerte Füße
extended legs

** zonder metalen verstevigingsprofielen onder het zitvlak en het tafelblad
sans renforts métalliques au-dessous des assises et tablettes
Ohne metalen Verstärkungsprofilen unter die Sitzfläche und unter die Tischplatte
without countersunk galvanised profiles

optie option Option option	beschrijving description Beschreibung description	prijs prix Preis price
Bicolor OSLO	tafelvoeten altijd zwart, planken grijs, bruin, beige of groen pieds toujours en noir, planches en gris, brun, beige ou vert Füße immer schwarz, Bretter grau, braun, beige oder grün legs always black, boards either grey, brown, beige or green	= beige







De zitbanken en tafels zijn voorzien van metalen verstevigingsprofielen onder het zitvlak en het tafelblad.
Les bancs et tables sont pourvus de renforts métalliques au-dessous des assises et tablettes
Die Bänke und Tische sind ausgestattet mit metallenen Verstärkungsprofilen unter die Sitzfläche und unter die Tischplatte
The benches and tables are reinforced with countersunk galvanised profiles

1 verankeringspunt
(tel het aantal verankeringspunten !)
aanbevolen optie p.19
één verankeringsset per verankeringspunt

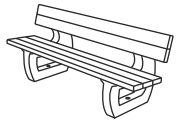
1 point d'ancrage
(comptez le nombre de points d'ancrage !)
option recommandée p.19
un set d'ancrage par point d'ancrage

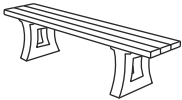
1 Verankerungspunkt
(zählen Sie die Verankerungspunkte !)
empfohlene Option p.19
ein Verankerungssatz pro Verankerungspunkt

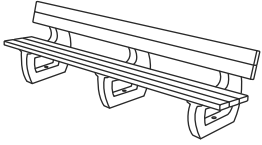
1 anchorage point
(count the anchorage points !)
recommended option p.19
one anchorage set per anchorage point

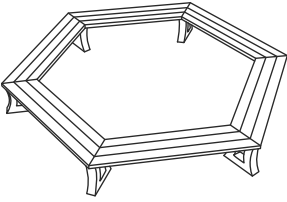
banken bancs Bänke benches			prijs / st. prix / pc. Preis / St. price / pc.			
beschrijving description Beschreibung description	afm. (cm) dim. (cm) Abm. (cm) dim. (cm)	gewicht poids Gewicht weight	grijs of zwart gris ou noir grau oder schwarz grey or black	bruin brun braun brown	groen vert grün green	
BONN ML	180	83 kg	287 €	292 €	325 €	 
BONN ZL	180	50 kg	201 €	206 €	221 €	 
BONN ML 360 cm	360	142 kg	480 €	488 €	542 €	 
BONN ZL 360° (120 cm) *	240 x 240	164 kg	744 €	759 €	806 €	 
BONN ZL 360° (180 cm)	360 x 360	216 kg	969 €	988 €	1044 €	

* zonder metalen verstevigingsprofielen onder het zitvlak
sans renforts métalliques au-dessous des assises
Ohne metallenen Verstärkungsprofilen unter die Sitzfläche
withot countersunk galvanised profiles

optie option Option option	bicolor	beschrijving description Beschreibung description	prijs prix Preis price
	BONN ML	bankvoeten altijd zwart, planken grijs, bruin, beige of groen pieds toujours en noirs, planches en gris, brun, beige ou en vert Füße immer schwarz, Bretter sind grau, braun, beige oder grün legs always black, boards either grey, brown, beige or green	336 €
	BONN ZL		229 €
	BONN ML 360 cm		563 €
	bank BONN ZL 360° (120 cm)		832 €
	bank BONN ZL 360° (180 cm)		1083 €

De zitbanken en tafels zijn voorzien van metalen verstevigingsprofielen onder het zitvlak en het tafelblad.
Les bancs et tables sont pourvus de renforts métalliques au-dessous des assises et tablettes
Die Bänke und Tische sind ausgestattet mit metallenen Verstärkungsprofilen unter die Sitzfläche und unter die Tischplatte
The benches and tables are reinforced with countersunk galvanised profiles











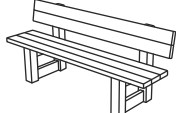

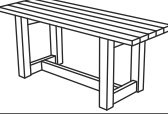

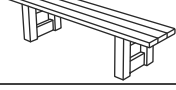
1 verankeringspunt
(tel het aantal verankeringspunten !)
aanbevolen optie p.19
één verankeringsset per verankeringspunt

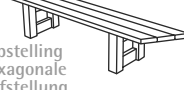
1 point d'ancrage
(comptez le nombre de points d'ancrage !)
option recommandée p.19
un set d'ancrage par point d'ancrage

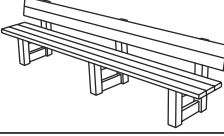

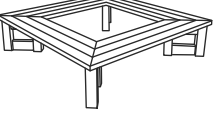

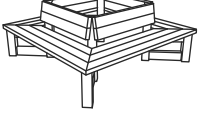

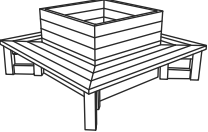
1 Verankerungspunkt
(zählen Sie die Verankerungspunkte !)
empfohlene Option p.19
ein Verankerungssatz pro Verankerungspunkt

1 anchorage point
(count the anchorage points !)
recommended option p.19
one anchorage set per anchorage point

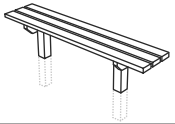
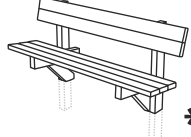
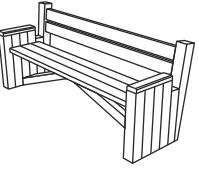

banken en tafels bancs et tables Bänke und Tische benches and tables			prijs / st. prix / pc. Preis / St. price / pc.					
beschrijving description Beschreibung description	afm. (cm) dim. (cm) Abm. (cm) dim. (cm)	gewicht poids Gewicht weight	grijs of zwart gris ou noir grau oder schwarz grey or black	bruin brun braun brown	groen vert grün green	beige beige beige beige		
LONDON ML	180	87 kg	295 €	300 €	312 €	329 €		
LONDON T	180	95 kg	387 €	394 €	408 €	429 €		
LONDON ZL	180	51 kg	217 €	220 €	227 €	238 €		
LONDON 60°	180	48 kg	231 €	234 €	241 €	252 €		 voor zeshoekige opstelling pour formation hexagonale für sechseckige Aufstellung for hexagonal formation
LONDON ML 360 cm	360	126 kg	502 €	513 €	534 €	552 €		
LONDON 4ZL	180 x 180	180 kg	778 €	790 €	813 €	848 €		
LONDON 4ML	180 x 180	225 kg	981 €	999 €	1035 €	1089 €		
LONDON 4ZL (met bloembak) (avec bac à fleurs) (mit Blumenkasten) (with planter)	180 x 180	420 kg	1589 €	1626 €	1699 €	1810 €		

optie option Option option	beschrijving description Beschreibung description	prijs prix Preis price
Bicolor LONDON ...	bank- en tafelhoeten altijd zwart, planken grijs, bruin, beige of groen pieds toujours en noir, planches en gris, brun, beige ou vert Füße immer schwarz, Bretter sind grau, braun, beige oder grün legs always black, boards either grey, brown, beige or green	= beige

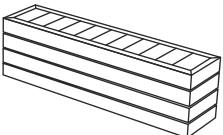
banken en tafels bancs et tables Bänke und Tische benches and tables			prijs / st. prix / pc. Preis / St. price / pc.				* = verlengde poten pieds prolongés verlängerte Füße extended legs
beschrijving description Beschreibung description	afm. (cm) dim. (cm) Abm. (cm) dim. (cm)	gewicht poids Gewicht weight	grijs of zwart gris ou noir grau oder schwarz grey or black	bruin brun braun brown	groen vert grün green	beige beige beige beige	
PORTO <i>bankvoeten altijd zwart pieds toujours en noir Füße immer schwarz legs always black</i>	180	70 kg	259 €	262 €	270 €	280 €	 
SOFIA	180	50 kg	204 €	208 €	215 €	225 €	 *
PARIS	180	86 kg	283 €	289 €	301 €	319 €	 *
PALERMO steeds te verankeren ! toujours à ancre ! immer zu verankern ! Always to be anchored !	180	120 kg	567 €	580 €	608 €	649 €	 Steeds te verankeren ! Verankerung inbegrepen. Toujours à ancrer ! Ancrage inclus. Immer zu verankern ! Verankerung einbegriffen. Always to be anchored ! Anchorage included.
WINDSOR	240	110 kg	771 €	783 €	807 €	842 €	 
AGORA	180	140 kg	582 €	596 €		663 €	 

 =
1 verankeringspunt (tel het aantal verankeringspunten !) aanbevolen optie p.19, één verankeringsset per verankeringspunt
1 point d'ancrage (comptez le nombre de points d'ancrage !) option recommandée p.19, un set d'ancrage par point d'ancrage
1 Verankerungspunkt (zählen Sie die Verankerungspunkte !) empfohlene Option p.19, ein Verankerungssatz pro Verankerungspunkt
1 anchorage point (count the anchorage points !) recommended option p.19, one anchorage set per anchorage point

optie option Option option	beschrijving description Beschreibung description	prijs prix Preis price
Bicolor PALERMO, SOFIA, PARIS	bankvoeten altijd zwart, planken grijs, bruin, beige of groen pieds toujours en noir, planches en gris, brun, beige ou vert Füße immer schwarz, Bretter grau, braun, beige oder grün legs always black, boards either grey, brown, beige or green	= beige















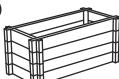

ronde anti-parkeerpalen met bolkop piquets anti-parking ronds à tête arrondie runde Parksperrren mit abgerundetem Kopf round traffic bollards with domed top					prijs / st. prix / pc. Preis / St. price / pc.	
afm. (cm) dim. (cm) Abm. (cm) dim. (cm)	beschrijving description Beschreibung description	st. / pal. pcs./ pal. St. / Pal. pcs./ pal.	gewicht poids Gewicht weight	zwart noir schwarz black		
ø 13,5 x 145	met witte reflectieband 50 mm avec bande réfléchissante blanc 50 mm mit Reflektorbänd weiß 50 mm with white reflective strip 50 mm	56	13,6 kg	35,42 €		

vierkante anti-parkeerpalen piquets anti-parking carrés viereckige Parksperrren square traffic bollards					prijs / st. prix / pc. Preis / St. price / pc.	
afm. (cm) dim. (cm) Abm. (cm) dim. (cm)	beschrijving description Beschreibung description	st. / pal. pcs./ pal. St. / Pal. pcs./ pal.	gewicht poids Gewicht weight	zwart noir schwarz black	bruin brun braun brown	
15 x 15 x 140	diamantkop en vellingkanten incl. 2 reflectiebanden 18mm (wit-rood) chanfreiné, tête diamant 2 bandes réfléchissantes 18 mm inclus (blanc-rouge) mit Diamantkopf und Fasen incl. 2 Reflektorbänder 18 mm (weiß - rot) chamfered, with diamond top incl. 2 reflective strips 18 mm (white-red)	49	14,5 kg	38,27 €	42,05 €	







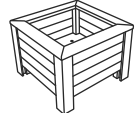

optie option Option option	meerprijs 2 reflectoren (wit of oranje) + infrezen supplément 2 réflecteurs (blanc ou jaune) + fraisure Mehrpreis 2 Katzenaugen (weiß oder orange) + einfräsen extra charge 2 reflectors (white or orange) + milling	prijs 2 st. prix 2 pcs. Preis 2 St. price 2 pcs.	
	7 x 11 cm	13,80 €	

wegneembare anti-parkeerpalen piquets anti-parking amovibles entfernbare Parksperrren removable traffic bollards					prijs / st. prix / pc. Preis / St. price / pc.	 <p>A</p> <p>B</p>
afm. (cm) dim. (cm) Abm. (cm) dim. (cm)	beschrijving description Beschreibung description	st. / pal. pcs./ pal. St. / Pal. pcs./ pal.	gewicht poids Gewicht weight	zwart noir schwarz black	bruin brun braun brown	
15 x 15 x 132	paal + voet piquet + pied Parksperrre + Fuß bollard + socket	20	19,5 kg	241,68 €	245,46 €	
15 x 15 x 80	vervangpaal piquet remplacement Ersatz Parksperrre bollard spare	20	11,5 kg	221,49 €	225,27 €	
Met diamantkop en vellingkanten, steeds voorzien van 2 reflectiebanden 18 mm (wit-rood) Met grondverankeringsmechanisme en sleutel Chanfreiné, tête diamant, piquet toujours muni de 2 bandes réfléchissantes 18 mm (blanc - rouge) avec tige d'ancrage et clef Mit Diamantkopf und Fasen, immer mit 2 Reflektorbänder 18 mm (weiß - rot) Mit Abschlusstange und Schlüssel Chamfered, with diamond top, always with 2 reflective strips 18 mm (white - red) Supplied with locking bar and key						



bloembakken bacs à fleurs Blumenkäste planters			prijs / st. prix / pc. Preis / St. price / pc.				1 verankeringspunt, aanbevolen optie p.19 één verankeringsset per verankeringspunt 1 point d'ancrage, option recommandée p.19 un set d'ancrage par point d'ancrage 1 Verankerungspunkt, empfohlene Option p.19 ein Verankerungssatz pro Verankerungspunkt 1 anchorage point, recommended option p.19 one anchorage set per anchorage point		
beschrijving description Beschreibung description	afm. (cm) dim. (cm) Abm. (cm) dim. (cm)	gewicht poids Gewicht weight	grijs of zwart gris ou noir grau oder schwarz grey or black	bruin brun braun brown	groen vert grün green	beige beige beige beige			
BARCELONA	ø 90 x h 36	53 kg	342 €	347 €	355 €	368 €		 *	
	ø 90 x h 60	83 kg	446 €	453 €	467 €	488 €			
	ø 90 x h 84	112 kg	563 €	573 €	593 €	622 €		 *	
	ø 120 x h 36	63 kg	406 €	412 €	423 €	441 €			
	ø 120 x h 60	101 kg	526 €	536 €	554 €	582 €			
	ø 120 x h 84	140 kg	661 €	674 €	700 €	739 €			
BERLIN	A	60 x 60 x 36	43 kg	318 €	322 €	329 €	340 €		 *
		60 x 60 x 48	56 kg	361 €	367 €	378 €	395 €		
		60 x 60 x 60	69 kg	389 €	395 €	408 €	428 €		
	B	60 x 120 x 48	84 kg	418 €	426 €	441 €	463 €		 *
		60 x 120 x 60	101 kg	464 €	473 €	492 €	520 €		
	C	90 x 90 x 48	84 kg	423 €	431 €	446 €	468 €		 *
90 x 90 x 60		100 kg	465 €	475 €	493 €	521 €			
MADRID	A	60 x 60 x 36	47 kg	262 €	266 €	275 €	288 €		 *
		60 x 60 x 60	72 kg	327 €	333 €	346 €	366 €		
	B	60 x 120 x 36	70 kg	319 €	325 €	336 €	353 €		 *
		60 x 120 x 60	108 kg	414 €	423 €	442 €	470 €		
		60 x 120 x 84	146 kg	562 €	575 €	600 €	639 €		
	C	90 x 90 x 36	70 kg	312 €	318 €	329 €	346 €		 *
		90 x 90 x 60	108 kg	415 €	425 €	443 €	471 €		
90 x 90 x 84		146 kg	564 €	577 €	602 €	641 €			
MILANO	A	60 x 60 x 50	45 kg	249 €	255 €	265 €	281 €		
		60 x 60 x 62	56 kg	277 €	283 €	295 €	313 €		
		60 x 60 x 74	67 kg	313 €	320 €	335 €	357 €		
	B	75 x 75 x 50	56 kg	301 €	308 €	322 €	343 €		
		75 x 75 x 62	69 kg	312 €	319 €	334 €	356 €		
		75 x 75 x 74	82 kg	355 €	364 €	382 €	410 €		

optie option Option option	beschrijving description Beschreibung description	prijs prix Preis price
BARCELONA *	3 poten 4 x 12 cm / 3 pieds 4 x 12 cm / 3 Füße 4 x 12 cm / 3 legs 4 x 12 cm	40 €
BERLIN, MADRID *	poten : onderbalken 10 x 10 cm pieds : piquets carrés 10 x 10 cm Füße: Unterbalken 10 x 10 cm legs: square posts 10 x 10 cm	A
		B
		C
Bicolor MILANO	poten en rand in zwart, planken grijs, bruin, beige of groen pieds et bord en noir, planches en gris, brun, beige ou vert Füße und Rand schwarz, Bretter grau, braun, beige oder grün legs and edge black, boards grey, brown, beige or green	= beige

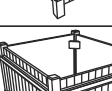
bloembakken bacs à fleurs Blumenkäste planters			prijs / st. prix / pc. Preis / St. price / pc.					
beschrijving description Beschreibung description	afm. (cm) dim. (cm) Abm. (cm) dim. (cm)	gewicht poids Gewicht weight	zwart of grijs noir ou gris schwarz oder grau black or grey	bruin brun braun brown	groen vert grün green	beige beige beige beige		
NAPOLI	ø 90, h 55	59 kg	464 €	471 €	485 €	506 €		
	ø 90, h 69	72 kg	522 €	531 €	549 €	576 €		
	ø 90, h 83	85 kg	587 €	597 €	618 €	650 €		
	ø 120, h 55	76 kg	523 €	531 €	548 €	572 €		
	ø 120, h 69	89 kg	587 €	597 €	618 €	650 €		
	ø 120, h 83	112 kg	663 €	675 €	700 €	738 €		
PALMA	70 x 70 x 70	71kg	504 €	512 €	528 €	552 €		
	105 x 105 x 70	118 kg	599 €	608 €	627 €	654 €		
VIENNA	A	ø 60, h 52	42 kg	328 €	331 €	339 €	350 €	 *
		ø 60, h 64	50 kg	377 €	381 €	390 €	403 €	
		ø 60, h 76	58 kg	426 €	431 €	441 €	457 €	
	B	ø 80, h 52	55 kg	362 €	367 €	377 €	391 €	 *
		ø 80, h 64	66 kg	418 €	424 €	435 €	453 €	
		ø 80, h 76	77 kg	469 €	475 €	488 €	508 €	
	C	ø 90, h 52	70 kg	378 €	384 €	394 €	409 €	 *
		ø 90, h 64	84 kg	434 €	440 €	453 €	472 €	
		ø 90, h 76	98 kg	490 €	498 €	512 €	534 €	
VERSAILLES boombak jardinière pour arbres Baumkübel tree planter	105 x 105 x 110	194 kg	1072 €	1089 €	1123 €	1175 €		
	125 x 125 x 110	223 kg	1347 €	1367 €	1409 €	1471 €		
	155 x 155 x 110	271 kg	1773 €	1799 €	1852 €	1931 €		

optie option Option option	beschrijving description Beschreibung description	prijs prix Preis price
Bicolor NAPOLI, PALMA en VERSAILLES	poten en rand in zwart, planken grijs, bruin, beige of groen pieds et bord de finition en noir, planches en gris, brun, beige ou vert Füße und Rand immer schwarz, Bretter grau, braun, beige oder grün legs and edge black, planks grey, brown, beige or green	= beige
VIENNA *	poten: onderbalken 4 x 12 cm pieds: piquets carrés 4 x 12 cm Füße: Unterbalken 4 x 12 cm legs: square posts 4 x 12 cm	A 33 € B 40 € C 40 €

bloembakken ROTTERDAM bacs à fleurs ROTTERDAM Blumenkäste ROTTERDAM planters ROTTERDAM			prijs / st. prix / pc. Preis / St. price / pc.		
beschrijving description Beschreibung description	afm. (cm) dim. (cm) Abm. (cm) dim. (cm)	gewicht poids Gewicht weight	grijs of zwart gris ou noir grau oder schwarz grey or black	bruin brun braun brown	groen vert grün green
ROTTERDAM	60 x 60 x 36	43 kg	215 €	220 €	226 €
	60 x 60 x 48	54 kg	251 €	256 €	266 €
	60 x 60 x 60	66 kg	284 €	290 €	303 €
	90 x 90 x 48	83 kg	321 €	329 €	344 €
	90 x 90 x 60	101 kg	369 €	379 €	397 €
	120 x 60 x 48	70 kg	301 €	307 €	320 €
	120 x 60 x 60	75 kg	343 €	351 €	367 €
	120 x 120 x 48	95 kg	408 €	417 €	434 €
120 x 120 x 60	115 kg	453 €	464 €	485 €	

* poten: onderbalken
pieds: piquets carrés
FüÙe: Unterbalken
legs: square posts

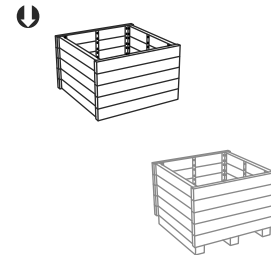

* onderbalken: zie opties
pieds: voir options
FüÙe: siehe Option
legs: see options

bloembakken AGORA bacs à fleurs AGORA Blumenkäste AGORA planters AGORA			prijs / st. prix / pc. Preis / St. price / pc.		
beschrijving description Beschreibung description	afm. (cm) dim. (cm) Abm. (cm) dim. (cm)	gewicht poids Gewicht weight	grijs of zwart gris ou noir grau oder schwarz grey or black	bruin brun braun brown	beige
AGORA	60 x 45 x 52	50 kg	431 €	435 €	459 €
	90 x 45 x 52	72 kg	478 €	484 €	514 €
	120 x 45 x 52	88 kg	532 €	540 €	577 €
	180 x 45 x 52	119 kg	643 €	653 €	704 €
	270 x 45 x 52	168 kg	818 €	833 €	902 €
	360 x 45 x 52	218 kg	957 €	974 €	1063 €
	45 x 45 x 52	48 kg	417 €	422 €	445 €
	60 x 60 x 52	64 kg	463 €	469 €	497 €
	90 x 90 x 52	104 kg	580 €	588 €	630 €
120 x 120 x 52	149 kg	704 €	716 €	774 €	

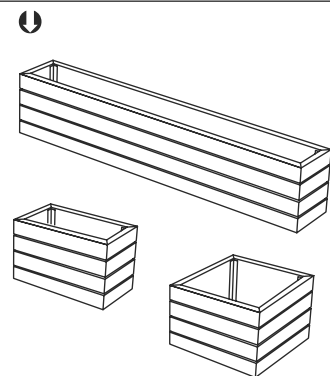

1 verankeringspunt (tel het aantal verankeringspunten !) aanbevolen optie p.19, één verankeringsset per verankeringspunt
1 point d'ancrage (comptez le nombre de points d'ancrage !) option recommandée p.19, un set d'ancrage par point d'ancrage
1 Verankeringspunkt (zählen Sie die Verankeringspunkte !) empfohlene Option p.19, ein Verankerungssatz pro Verankeringspunkt
1 anchorage point (count the anchorage points !) recommended option p.19, one anchorage set per anchorage point

optie option Option option	beschrijving description Beschreibung description	afm. (cm) dim. (cm) Abm. (cm) dim. (cm)	prijs prix Preis price
ROTTERDAM 60 x 60	poten : onderbalken 10 x 10 cm pieds: piquets carrés 10 x 10 cm FüÙe: Unterbalken 10 x 10 cm legs: square posts 10 x 10 cm	10 x 10	47 €
ROTTERDAM 90 x 90			71 €
ROTTERDAM 120 x 60			56 €
ROTTERDAM 120 x 120			86 €

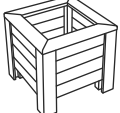
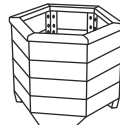
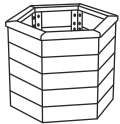
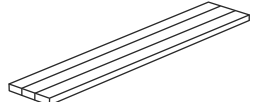
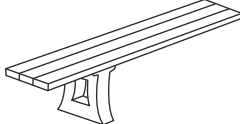
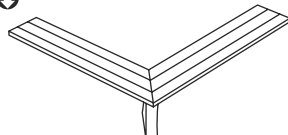
zitgroepen bancs modulaires Sitzgruppen sitting areas				prijs / st. prix / pc. Preis / St. price / pc.				
beschrijving description Beschreibung description	afm. (cm) dim. (cm) Abm. (cm) dim. (cm)	gewicht poids Gewicht weight	grijs of zwart gris ou noir grau oder schwarz grey or black	bruin brun braun brown	groen vert grün green	beige beige beige beige		
bloembak MILANO bac à fleurs MILANO Blumenkasten MILANO planter MILANO	60 x 60 x 62	56 kg	277 €	283 €	295 €	313 €		
bloembak VIENNA met poten bac à fleurs VIENNA avec pieds Blumenkasten VIENNA mit Füßen planter VIENNA with legs	ø 80 , H 64	60 kg	404 €	409 €	420 €	435 €		
bloembak VIENNA zonder poten bac à fleurs VIENNA sans pieds Blumenkasten VIENNA ohne Füße planter VIENNA without legs	ø 80 , H 64	66 kg	418 €	424 €	435 €	453 €		
combinatiebank voor bevestiging tussen 2 bloembakken banc à monter entre 2 bacs à fleurs Kombinationsbank für Montage zwischen 2 Blumenkäste seat to be assembled between 2 planters	180	35 kg	229 €	231 €	236 €	243 €		
combinatiebank met voet voor bevestiging aan 1 bloembak banc avec 1 pied à monter contre un bac à fleurs Kombinationsbank mit Fuß für Befestigung an 1 Blumenkasten seat with 1 leg to be assembled to 1 planter	180	42 kg	235 €	239 €	249 €	256 €		
combinatiehoekbank met centrale voet voor bevestiging tussen 2 bloembakken banc de coin avec pied central à monter entre 2 bacs à fleurs Kombinationseckenbank mit zentralem Fuß für Montage zwischen 2 Blumenkäste corner bench with 1 central leg to be assembled between 2 planters	2 x 180	70 kg	411 €	417 €	431 €	445 €		

Zitgroepen zijn een combinatie van bloembakken en zitbanken. Het standaard gamma bestaat uit 2 modellen bloembakken en 3 modellen zitbanken waarmee naar wens combinaties kunnen worden gemaakt.

Andere modellen mogelijk op aanvraag.

Les bancs modulaires se composent de bacs à fleurs et de bancs. La gamme standard comprend 2 modèles de bacs à fleurs et 3 modèles de bancs avec lesquels des combinaisons peuvent être faites. Autres modèles sur demande.

Sitzgruppen sind Kombinationen von Blumenkästen und Bänke. Die standard Produktpalette umfasst zwei Modelle Blumenkäste und drei Modelle Bänke. Andere Modelle auf Anfrage lieferbar.

Sitting areas are a combination of planters and seats. The standard range consists of 2 models of planters and 3 models of seats, other models of planters are available on request.

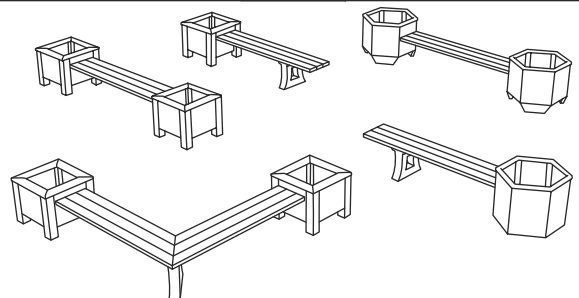

optie option Option option	beschrijving description Beschreibung description	prijs prix Preis price
Bicolor bloembak Bicolor bac à fleur Bicolor Blumenkasten Bicolor planter	poten en rand in zwart, planken grijs, bruin, beige of groen pieds et bord en noir, planches en gris, brun, beige ou vert Füße und Rand immer schwarz, Bretter grau, braun, beige oder grün legs and edge black, planks grey, brown, beige or green	= beige
Bicolor combinatiebank met voet Bicolor banc avec 1 pied Bicolor Kombinationsbank mit Fuß Bicolor seat with 1 leg	bankvoet zwart, planken grijs, bruin, beige of groen pied en noir, planches en gris, brun, beige ou vert Fuß immer schwarz, Bretter grau, braun, beige oder grün leg black, boards grey, brown, beige or green	= beige
Bicolor combinatiehoekbank met centrale voet Bicolor banc de coin avec pied central Bicolor Kombinationseckenbank mit zentralem Fuß Bicolor corner bench with 1 central leg	bankvoet zwart, planken grijs, bruin, beige of groen pied en noir, planches en gris, brun, beige ou vert Fuß immer schwarz, Bretter grau, braun, beige oder grün leg black, boards grey, brown, beige or green	= beige

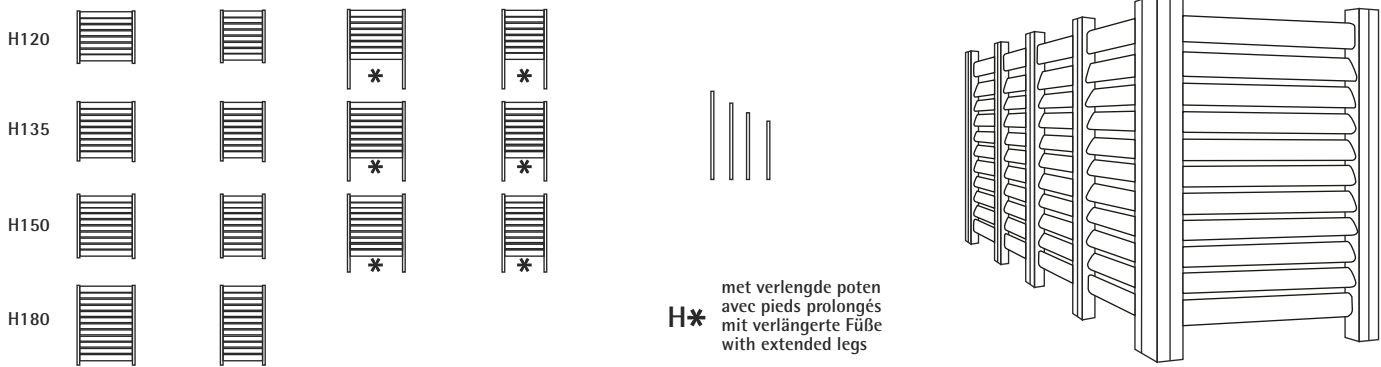



Omheiningsscherm Normandie clôture Normandie Zaun Normandie Fencing Normandie			prijs / st. prix / pc. Preis / St. price / pc.							
beschrijving description Beschreibung description	afm. (cm) dim. (cm) Abm. (cm) dim. (cm)	gewicht poids Gewicht weight	grijs of zwart gris ou noir grau oder schwarz grey or black		bruin brun braun brown		groen vert grün green		beige beige beige beige	
scherm panneau Zaun Fence	100 x H120	40 kg	190 €	151 €	194 €	155 €	202 €	163 €	214 €	175 €
	130 x H120	50 kg	207 €	168 €	212 €	172 €	221 €	182 €	236 €	197 €
	100 x H120 (+ H*60cm)	55 kg	200 €	161 €	205 €	165 €	214 €	175 €	227 €	188 €
	130 x H120 (+ H*60cm)	60 kg	223 €	183 €	228 €	189 €	240 €	201 €	257 €	218 €
	100 x H135	45 kg	209 €	166 €	213 €	170 €	222 €	178 €	235 €	191 €
	130 x H135	55 kg	226 €	182 €	231 €	187 €	241 €	198 €	257 €	213 €
	100 x H135 (+ H*45cm)	60 kg	219 €	176 €	224 €	180 €	234 €	190 €	248 €	205 €
	130 x H135 (+ H*45cm)	70 kg	236 €	193 €	242 €	198 €	253 €	210 €	270 €	227 €
	100 x H150	55 kg	243 €	195 €	248 €	200 €	259 €	210 €	274 €	226 €
	130 x H150	65 kg	266 €	217 €	272 €	224 €	285 €	236 €	304 €	255 €
	100 x H150 (+ H*30cm)	55 kg	243 €	195 €	248 €	200 €	259 €	210 €	274 €	226 €
	130 x H150 (+ H*30cm)	65 kg	266 €	217 €	272 €	224 €	285 €	236 €	304 €	255 €
100 x H180	60 kg	277 €	222 €	282 €	228 €	294 €	239 €	311 €	256 €	
130 x H180	70 kg	299 €	245 €	306 €	251 €	320 €	265 €	340 €	286 €	
hoekpaal poteau d'angle Eckepfost corner post	H120 (6x12)	7,3 kg	28 €		29 €		31 €		34 €	
	H135 (6x12)	8,2 kg	28 €		29 €		31 €		34 €	
	H150 (6x12)	9,1 kg	28 €		29 €		31 €		34 €	
	H180 (6x12)	11 kg	28 €		29 €		31 €		34 €	
	H120 (6x12)(+ H*60cm)	11 kg	28 €		29 €		31 €		34 €	
	H135 (6x12)(+ H*45cm)	11 kg	28 €		29 €		31 €		34 €	
	H150 (6x12)(+ H*30cm)	11 kg	28 €		29 €		31 €		34 €	

... €

= Prijs niet geassembleerd / Prix non assemblé / Preis nicht assembliert / Price not assembled

beschrijving description Beschreibung description	gewicht poids Gewicht weight	prijs / st. prix / pc. Preis / St. price / pc.
Gegalvaniseerde tussenvoet (schroeven niet inbegrepen, afhankelijk van bodem) platine de fixation galvanisée (vis non inclus, dépendants du sol) galvanisierter Zwischenfuß (Schrauben nicht mitgeliefert, abhängig vom Boden) galvanized middle support (screws not included, depending on the ground)	2 kg	98 €
Gegalvaniseerde hoekvoet (schroeven niet inbegrepen, afhankelijk van bodem) platine de fixation (angle) galvanisée (vis non inclus, dépendants du sol) galvanisierter Eckfuß (Schrauben nicht mitgeliefert, abhängig vom Boden) galvanized corner support (screws not included, depending on the ground)	2,5 kg	102 €

grondverankeringen ancrages Bodenverankerungen anchorages	beschrijving description Beschreibung description	prijs prix Preis price
 <p>verankering-set set d'ancrage Verankerungssatz anchorage set</p> <p>één verankeringset per verankeringpunt un set d'ancrage par point d'ancrage ein Verankerungssatz pro Verankerungspunkt one anchorage set per anchorage point</p>	<p>1 DIN 975 draadstang verzinkt M12 x 250mm + 1 verzinkte dopmoer DIN 1587 verzinkt M12 + 1 DIN 934 zeskantmoer verzinkt M12 + 1 sluitring DIN 125A verzinkt M12</p> <p>1 tige fileté DIN 975 galvanis�e M12 x 250mm + 1 �crou borgne DIN 1587 galvanis�e M12 + 1 �crou galvanis�e DIN 934 M12 + 1 rondelle galvanis�e DIN 125A M12</p> <p>1 galvanisierte Gewindestange DIN 975 M12 x 250 mm + 1 galvanisierte Hutmutter DIN 1587 M12 + 1 galvanisierte Mutter DIN 934 M12 + 1 galvanisierte Unterlegscheib DIN 125A M12</p> <p>1 galvanized threaded bolt M12 x 250mm + 1 galvanized acorn nut DIN 1587 M12 + 1 galvanized nut DIN 934 M12 + 1 galvanized washer DIN 125A M12</p>	7,50 €
 <p>CANVAS verankering-set set d'ancrage Verankerungssatz anchorage set</p> <p>�e�n verankeringset per verankeringpunt un set d'ancrage par point d'ancrage ein Verankerungssatz pro Verankerungspunkt one anchorage set per anchorage point</p>	<p>1 verzinkte draadstang DIN 975 M10 x 250 mm + 1 RVS hulsmoer M10 x 20</p> <p>1 tige filet�e galvanis�e DIN 975 M10 x 250 mm + 1 �crou borgne traversant inox M10 x 20</p> <p>1 galvanisierte Gewindebolzen DIN 975 M10 x 250 mm + 1 Edelstahl H�ulsenmutter M10 x 20</p> <p>1 galvanized threaded bar DIN 975 M10 x 250 mm + 1 stainless steel sleeve nut M10 x 20</p>	6,60 €

! zie ook technische fiche "verankering"
consultez aussi fiche technique "ancrage"
beachten Sie auch technisches Datenblatt "Verankerung"
see technical data "anchorage"

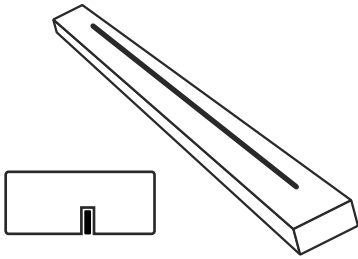
bankprofiel met versteviging profil�e de banc renforc�e Bankprofil mit Verst�rkung reinforced bench profile			prijs / st. prix / pc. Preis / St. price / pc.				
afm. (cm) dim. (cm) Abm. (cm) dim. (cm)	st. / pal. pcs. / pal. St. / Pal. pcs. / pal.	gewicht poids Gewicht weight	grijs of zwart gris ou noir grau oder schwarz grey or black	bruin brun braun brown	groen vert gr�n green	beige beige beige beige	
4 x 12 x 180	72	9 kg	28,30 €	29,10 €	30,50 €	32,70 €	
5 x 12 x 180	72	12 kg	32,30 €	33,30 €	35,10 €	37,90 €	

De maximale overspanbare afstand is 145 cm.
La port e maximale est de 145 cm.
Die maximale Spannweite ist 145 cm.
The maximum span is 145 cm.

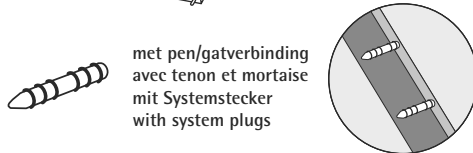
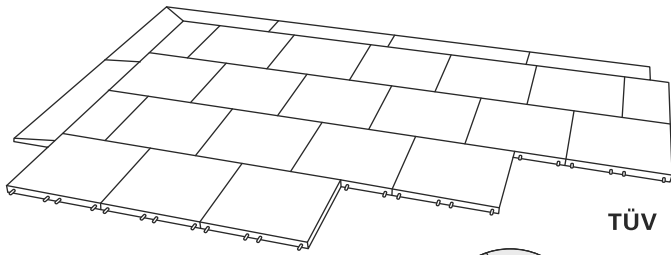

met pen/gatverbinding
avec tenon et mortaise
mit Systemstecker
with system plugs

Volg bij voorkeur steeds de voorschriften* van de fabrikant/
leverancier van het speeltoestel of raadpleeg de norm EN 1177
(* verplicht te leveren bij het speeltoestel)

De préférence toujours suivre les prescriptions * du
fabricant/fournisseur du jeu ou consulter norme EN 1177
(* obligatoirement à livrer avec le jeu)

Es ist empfehlenswert immer die Vorschriften* des Herstellers/
Lieferantes des Spielzeuges zu folgen oder Norm EN 1177
heranzuziehen.

(* verbindlich zusammen mit dem Spielzeug zu liefern)

Preferably always follow instructions* of manufacturer/supplier
of the playground equipment or consult EN 1177
(* obligatory to be supplied together with equipment)



valbrekende tegel
dalle antichute
Fallschutzplatte
safety tile

Standaardkleur : roodbruin (zwart, groen, grijs op aanvraag)
Couleur standard : rougebrun (noir, vert, gris sur demande)
Standard Farbe : rotbraun (schwarz, grün, grau auf Anfrage)
Standard colour : redbrown (black, green, grey on demand)

dikte épaisseur Stärke thickness	afm. (mm) dim. (mm) Abm. (mm) dim. (mm)	valhoogte hauteur de chute Fallschutz impact protection	gewicht poids Gewicht weight	st. / pal. pcs./ pal. St. / Pal. pcs./ pal.	m ² / pal. m ² / pal. m ² / Pal. m ² / pal.	prijs / m ² prix / m ² Preis / m ² price / m ²	meerprijs zwart, groen, grijs supplément noir, vert, gris Afschlag schwarz, grün, grau supplément black, green, grey
30 mm	500 x 500 mm	1 m	20,8 kg/m ²	180	45 m ²	41,60 €	4,8 €
40 mm	500 x 500 mm	1,2 m	26 kg/m ²	140	35 m ²	43,00 €	4,8 €
50 mm	500 x 500 mm	1,5 m	30 kg/m ²	120	30 m ²	55,00 €	4,8 €
70 mm	500 x 500 mm	2,1 m	41,6 kg/m ²	80	20 m ²	60,40 €	4,8 €
80 mm	500 x 500 mm	2,4 m	48 kg/m ²	80	20 m ²	69,40 €	4,8 €

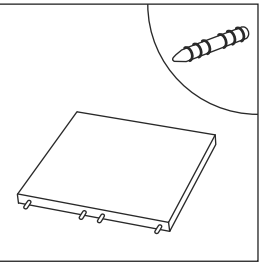

Randtegel
dalle bord
Randplatte
border tile

steeds op aanvraag !
toujours sur demande !
immer auf Anfrage !
always on demand !

roodbruin, zwart, groen, grijs
rougebrun, noir, vert, gris
rotbraun, schwarz, grün, grau
redbrown black, green, grey

type type Typ type	dikte épaisseur Stärke thickness	afm. (mm) dim. (mm) Abm. (mm) dim. (mm)	gewicht/st. poids/pc. Gewicht/St. weight/pc.	st. / pal. pcs./ pal. St. / Pal. pcs./ pal.	prijs / st. prix / pc. Preis / St. price / pc.	meerprijs zwart, groen, grijs supplément noir, vert, gris Afschlag schwarz, grün, grau supplément black, green, grey
recht droit recht straight	30/10 mm	1000 x 250 mm	4 kg	120	14,10 €	3,25
	40/10 mm	1000 x 250 mm	6,2 kg	120	21,90 €	3,25
	50/20 mm	1000 x 250 mm	7,8 kg	100	23,30 €	3,25
	70/20 mm	1000 x 250 mm	8,5 kg	80	26,10 €	3,25
	80/20 mm	1000 x 250 mm	10,5 kg	80	36,70 €	3,25
hoek links of rechts angle droite ou gauche Ecke rechts oder links Corner left or right	30/10 mm	1000 x 250 mm	3,2 kg	120	14,10 €	3,50
	40/10 mm	1250 x 250 mm	6,8 kg	120	23,30 €	3,50
	50/20 mm	1250 x 250 mm	8,3 kg	100	26,10 €	3,50
	70/20 mm	1250 x 250 mm	9,2 kg	80	28,90 €	3,50
	80/20 mm	1000 x 250 mm	9 kg	80	38,10 €	3,50



zonder pen/gatverbinding : te lijmen
sans tenon et mortaise : à coller
ohne Systemstecker : zu kleben
without system plugs : to be glued

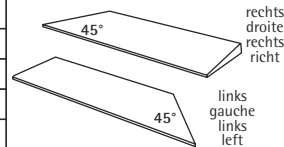
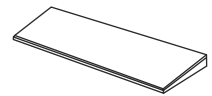

toepassingsgebieden:
applications:
ideale Einsatzgebiete:
fields of application:

- speeltuinen, speelpleinen
- terrains de jeux et jardins pour enfants
- Spielplätze, Spielfelder
- playgrounds, playing fields

- kleuterscholen, speelplaatsen
- écoles maternelles, cours de récréation
- Kindergarten, Schulhöfe
- nursery schools, school playgrounds

- recreatiezones
- aires de récréation
- Freizeitbereiche
- leisure areas

universele rubbertegel
dalle universelle en caoutchouc
Gummi Universalplatte
universal rubber tile

30 x 400 x 400 mm

valhoogte : 1m
hauteur de chute : 1m
Fallschutz : 1m
impact protection : 1m

kleur couleur Farbe colour	gewicht poids Gewicht weight	st. / m ² pcs./ m ² St. / m ² pcs./ m ²	st. / pal. pcs./ pal. St. / Pal. pcs./ pal.	m ² / pal. m ² / pal. m ² / Pal. m ² / pal.	prijs / st. prix / pc. Preis / St. price / pc.	prijs / m ² prix / m ² Preis / m ² price / m ²
roodbruin rougebrun rotbraun redbrown	22,5 kg/m ²	6,25	250	40	5,84 €	36,50 €
zwart noir schwarz black	22,5 kg/m ²	6,25	250	40	6,64 €	41,50 €
groen vert grün green	22,5 kg/m ²	6,25	250	40	6,64 €	41,50 €
grijs gris grau grey	22,5 kg/m ²	6,25	250	40	6,64 €	41,50 €

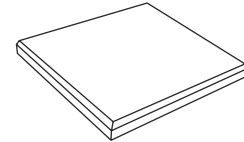

zonder pen/gatverbinding
sans tenon et mortaise
ohne Systemstecker
without system plugs

rubber op rol
caoutchouc sur rouleau
Matte auf Rolle
rubber on roll

10 x 1250 x 6000 mm

zwart
noir
schwarz
black

m ² / rol m ² / roul. m ² / Rolle m ² / roll	rollen / pal. roul./ pal. Rolle / Pal. rolls/ pal.	m ² / pal. m ² / pal. m ² / Pal. m ² / pal.	prijs / rol prix / roul. Preis / Rolle price / roll.	prijs / m ² prix / m ² Preis / m ² price / m ²	gewicht poids Gewicht weight
7,5 m ²	11	82,5	100,94 €	13,46 €	9 kg/m ²

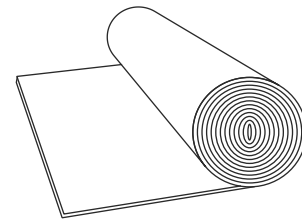

boordstenen
bordures
Bordsteine
edging beams

prijs / st.
prix / pc.
Preis / St.
price / pc.



afm. (cm) dim. (cm) Abm. (cm) dim. (cm)	st. / pal. pcs./ pal. St. / Pal. pcs./ pal.	gewicht poids Gewicht weight	prijs / st. prix / pc. Preis / St. price / pc.
5 x 26 x 250	30	33 kg	38,39 €

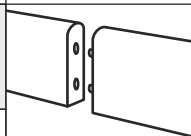

grastegels
dalles gazon
Rasengittersteine
grass tiles

prijs / st.
prix / pc.
Preis / St.
price / pc.

4,17 st/m²



afm. (cm) dim. (cm) Abm. (cm) dim. (cm)	st. / pal. pcs./ pal. St. / Pal. pcs./ pal.	gewicht poids Gewicht weight	prijs / st. prix / pc. Preis / St. price / pc.
10 x 60 x 40	60	12 kg	6,5 €



palissadepaaltjes
piquets de palissades
Hohlkehlpalisaden
palisades

prijs / st.
prix / pc.
Preis / St.
price / pc.



afm. (cm) dim. (cm) Abm. (cm) dim. (cm)	st. / pal. pcs./ pal. St. / Pal. pcs./ pal.	gewicht poids Gewicht weight	prijs / st. prix / pc. Preis / St. price / pc.
ø 10 x 60	140	3,9 kg	5,40 €
ø 10 x 80	100	5,2kg	7,21 €

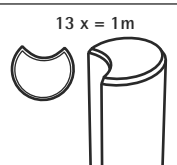

paalvoeten
pieds d'ancrage
Schilderhülse
ground fixing sockets

prijs / st.
prix / pc.
Preis / St.
price / pc.



afm. (cm) dim. (cm) Abm. (cm) dim. (cm)	st. / pal. pcs./ pal. St. / Pal. pcs./ pal.	gewicht poids Gewicht weight	prijs / st. prix / pc. Preis / St. price / pc.
27 x 27 x 50	30	8,6 kg	20,19 €
ø 51 mm		0,34 kg	4,46 €

Standaard model geschikt voor paal ø 76 mm
Met inzetstuk geschikt voor paal ø 51 mm

Modèle standard convient pour piquet ø 76 mm
Avec emplacement apte à piquet ø 51 mm

Standard Modell geeignet für Pfosten ø 76 mm
Mit Einsatz geeignet für Pfosten ø 51 mm

Standard model fit for post ø 76 mm
With adaptor fit for post ø 51 mm

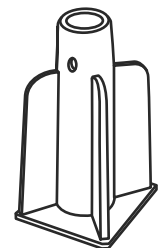

ø 51 mm



inzetstuk
emplacement
Einsatz
adaptor

Verkoopvoorwaarden Govaerts Recycling

1. Govaerts Recycling is enkel gebonden door haar eigen orderbevestiging en onderhavige voorwaarden, met uitdrukkelijke uitsluiting van de eigen contractuele voorwaarden van de Cliënt.

2. Elke vermelde leveringstermijn geldt ter informatie van de Cliënt. Tenzij anders overeengekomen vindt de levering plaats af fabriek van de betrokken vestiging van Govaerts Recycling te België. Vanaf dit ogenblik gaat het volledige risico van de goederen over op de Cliënt. Het vervoer van de goederen geschiedt altijd voor risico en op kosten van de Cliënt. Als Govaerts Recycling het transport dient te organiseren, doet zij dit steeds als aangestelde van de Cliënt.

3. Behoudens anders overeengekomen zijn alle facturen betaalbaar 30 dagen na factuurdatum. Betaling dient te geschieden op de vennootschapszetel van Govaerts Recycling te Alken (België). Zolang de geleverde goederen niet betaald zijn, blijven zij de uitsluitende eigendom van Govaerts Recycling. Elke onbetaalde factuur wordt vanaf haar vervaldag, van rechtswege en zonder ingebrekestelling verhoogd met de intrest tegen de referentie-intrestvoet vermeerderd met 7 procentpunten en afgerond tot het hogere halve procentpunt (art. 5 W. 02/08/2002). Elke onbetaalde factuur zal bovendien van rechtswege en zonder ingebrekestelling worden verhoogd met een forfaitaire vergoeding ten belope van 10% van het uitstaande factuurbedrag, behoudens indien de werkelijke invorderingskosten - met inbegrip van de kosten voor juridische bijstand - hoger zouden zijn (art. 6 W. 02/08/2002).

4. Govaerts Recycling garandeert de Cliënt de deugdelijkheid van de door haar afgeleverde goederen gedurende een periode van 2 jaar na de levering ervan. In geval van een door de Cliënt bewezen gebrekkige levering zal Govaerts Recycling naar haar goeddunken overgaan ofwel tot de omruiling van de gebrekkige goederen, ofwel tot de creëtering van de corresponderende factuur.

5. Govaerts Recycling garandeert de Cliënt de deugdelijkheid van de door haar geleverde Gopaplast-profielen gedurende een periode van 10 jaar na de levering ervan. Deze termijn gaat in vanaf de datum van de factuur van de betrokken levering. Het is aan de Cliënt om de gebrekkigheid van het Gopaplast-profiel te bewijzen. De garantie geldt niet voor verkleuring, noch uitzetting van de goederen te wijten aan de klimatologische en weeromstandigheden waaraan de Gopaplast-profielen worden blootgesteld. De garantie is evenmin van toepassing indien de gebreken werden veroorzaakt door normale slijtage of door het eigen gedrag van de Cliënt en/of derden (o.m. gebrekkige plaatsing en montage, niet-conform gebruik). Deze garantie-clausule geldt niet voor geassembleerde Gopaplast-profielen en voor Gopaplast-platen, waarvoor eigen garantiëpalingen gelden. De garantiëverplichting van Govaerts Recycling is strikt beperkt tot het voorgaande in 4 en 5.

6. Onverminderd haar recht op schadevergoeding is Govaerts Recycling in geval van niet-betaling op één enkele vervaldag of niet-naleving van elke andere contractuele verplichting door de Cliënt gerechtigd, ofwel de uitvoering van de overeenkomst op te schorten, ofwel de overeenkomst van rechtswege te ontbinden door de loutere verzending van een aangetekende brief.

7. Onderhavige transactie wordt beheerd door Belgisch recht. In geval van betwisting zullen de rechtbanken van Tongeren (België) exclusief bevoegd zijn, met dien verstande dat Govaerts Recycling gerechtigd is een betwisting aanhangig te maken voor de rechtbank van de zetel/woonplaats van de Cliënt.

Conditions de vente Govaerts Recycling

1. Govaerts Recycling est uniquement liée par sa propre confirmation de commande et les présentes conditions, à l'exclusion expresse des propres conditions contractuelles du Client.

2. Tout délai de livraison mentionné est donné à titre informatif. Sauf convention contraire, la livraison a lieu départ de l'usine concernée de Govaerts Recycling en Belgique. A partir de ce moment-là, le risque complet des marchandises est transféré au Client. Le transport des marchandises s'effectue toujours aux risques et aux frais du Client. Si Govaerts Recycling doit organiser le transport, elle le fait toujours en tant que préposée du Client.

3. Sauf convention contraire, toutes les factures sont payables à 30 jours date de facture. Le paiement doit avoir lieu au siège social de Govaerts Recycling à Alken (Belgique). Tant que les marchandises ne sont pas payées, elles demeurent la propriété exclusive de Govaerts Recycling. Dès son échéance, toute facture impayée est majorée de plein droit et sans mise en demeure d'un intérêt au taux directeur majoré de 7 points de pourcentage et arrondi au demi-point de pourcentage supérieur (art. 5 L. 02/08/2002). En outre, toute facture impayée sera majorée de plein droit et sans mise en demeure d'une indemnité forfaitaire de 10% du montant de la facture échue, sauf si les frais de recouvrement réels - y compris les frais d'assistance juridique - seraient plus élevés (art. 6 L. 02/08/2002).

4. Sauf Govaerts Recycling garantit au Client la bonne qualité de ses marchandises livrées pendant une période de 2 ans après leur livraison. En cas de livraison défectueuse prouvée par le Client, Govaerts Recycling procédera à son gré soit à l'échange des marchandises défectueuses, soit à l'établissement d'une note de crédit de la facture correspondante.

5. Govaerts Recycling garantit au Client la bonne qualité des profils Gopaplast qu'elle livre et ce, pendant une période de 10 ans après leur livraison. Ce délai prend cours à partir de la date de la facture de la livraison en question. Il appartient au Client de prouver la défectuosité du profil Gopaplast. La garantie ne s'applique pas à la décoloration ni au gonflement des marchandises dus aux conditions climatologiques et atmosphériques auxquelles les profils Gopaplast sont exposés. La garantie n'intervient pas non plus si les vices ont été causés par l'usure normale ou par le propre comportement du Client et/ou de tiers (e.a. placement et montage défectueux, utilisation non conforme). Cette clause de garantie n'est pas valable pour des profils Gopaplast assemblés et des plaques Gopaplast pour lesquels de propres dispositions de garantie sont en vigueur. L'obligation de garantie de Govaerts Recycling est strictement limitée à ce qui précède sous 4 et 5.

6. Sans préjudice de son droit à une indemnisation, Govaerts Recycling est habilitée, en cas de non-paiement à l'une des échéances ou de non-respect d'une autre obligation contractuelle par le Client, à suspendre l'exécution du contrat, à résilier de plein droit par le simple envoi d'un courrier recommandé.

7. La présente transaction est régie par le droit belge. En cas de litige, les tribunaux de Tongres (Belgique) seront exclusivement compétents, en ce compris que Govaerts Recycling est habilitée à saisir d'un litige le tribunal du siège/domicile du Client.

Verkaufsbedingungen Govaerts Recycling

1. Govaerts Recycling ist lediglich an ihre eigenen Auftragsbestätigungen und vorliegende Verkaufsbedingungen gebunden, unter ausdrücklichem Ausschluss der eigenen Vertragsbedingungen des Kunden.

2. Jede angegebene Lieferfrist gilt als Hinweis. Außer im Fall einer anderslautenden Vereinbarung findet die Lieferung ab Fabrik an der betreffende Niederlassung von Govaerts Recycling in Belgien statt. Ab diesem Zeitpunkt geht das vollständige Risiko der Waren auf den Kunden über. Der Transport der Waren erfolgt immer auf Risiko und Kosten des Kunden. Wenn Govaerts Recycling den Transport organisieren muss, erfolgt dies stets als Angestellte des Kunden.

3. Außer im Fall einer anderslautenden Vereinbarung sind alle Rechnungen 30 Tage nach Rechnungsdatum fällig. Die Bezahlung muss am Gesellschaftssitz von Govaerts Recycling in Alken (Belgien) erfolgen. Solange die gelieferten Waren nicht bezahlt sind, bleiben sie im ausschließlichen Eigentum von Govaerts Recycling. Jede unbezahlte Rechnung wird ab ihrem Fälligkeitstag, von Rechts wegen und ohne Inverzugsetzung um die Zinsen zum Referenzzinssatz erhöht, zuzüglich 7 Prozentpunkte und aufgerundet auf den höheren halben Prozentpunkt (Art. 5, Gesetz vom 02/08/2002). Jede Rechnung wird darüber hinaus von Rechts wegen und ohne Inverzugsetzung um eine pauschale Entschädigung in Höhe von 10 % des ausstehenden Rechnungsbetrages erhöht, es sei denn, dass die tatsächlichen Inkassokosten - einschließlich der Kosten für Rechtsberatung - höher sind (Art. 6 Gesetz vom 02/08/2002).

4. Govaerts Recycling garantiert dem Kunden die Gebrauchstauglichkeit der von ihr gelieferten Waren für einen Zeitraum von 2 Jahre nach deren Lieferung. Im Fall einer vom Kunden nachgewiesenen mangelhaften Lieferung wird Govaerts Recycling nach eigenem Gutdünken die mangelhaften Waren entweder umtauschen oder die entsprechende Rechnung kreditieren.

5. Govaerts Recycling garantiert dem Kunden, dass die von ihr gelieferten Gopaplast-Profile während 10 Jahren ab Lieferung keine Materialfehler aufweisen. Diese Frist beginnt am Rechnungsdatum der betreffenden Lieferung. Es ist Aufgabe des Kunden, Mängel an Gopaplast-Profilen nachzuweisen. Die Garantie gilt nicht für eine Verfärbung oder Ausdehnung der Waren aufgrund der Klima- und Wetterbedingungen, denen die Gopaplast-Profile ausgesetzt werden. Die Garantie gilt ebenso wenig, wenn die Mängel auf normale Abnutzung oder das eigene Verhalten des Kunden und/oder von Dritten zurückzuführen sind (u. a. falsche Anbringung und Montage, nicht sachgemäße Verwendung). Diese Garantieklausel gilt nicht für zusammengebaute Gopaplast-Profile und für Gopaplast-Platten, für die eigene Garantiebestimmungen gelten. Die Garantieverpflichtung von Govaerts Recycling ist strikt auf in 4 und 5 Vorhergehendes beschränkt.

6. Unvermindert ihres Rechtes auf Schadenersatz ist Govaerts Recycling im Fall der Nichtbezahlung an einem Fälligkeitstag oder Nichteinhaltung jeder anderen vertraglichen Verpflichtung durch den Kunden berechtigt, entweder die Ausführung der Vereinbarung auszusetzen, oder sie von Rechts wegen durch reine Versendung eines eingeschriebenen Briefes aufzulösen.

7. Vorliegende Transaktion unterliegt belgischem Recht. Im Fall einer Streitigkeit sind die Gerichte von Tongeren (Belgien) ausschließlich zuständig, unter der Voraussetzung, dass Govaerts Recycling berechtigt ist, eine Streitigkeit vor dem Gericht am Firmensitz/Wohnsitz des Kunden anhängig zu machen.

Sales conditions Govaerts Recycling

1. Govaerts Recycling is only bound to its own order confirmation and the present conditions, expressly excluding the Client's own contractual conditions.

2. Each delivery term is mentioned for information purposes only. Unless otherwise agreed, the delivery will take place ex works from the relevant place of business of Govaerts Recycling in Belgium. From that moment all risks associated with the goods are transferred to the Client. Transport of the goods will always occur at the Client's own risk and expense. Should Govaerts Recycling need to organise the transport, they will always undertake this as the Client's agents.

3. Except otherwise agreed, all invoices are payable 30 days after the invoice date. Payment needs to be made to Govaerts Recycling's registered place of business in Alken (Belgium). The goods remain the exclusive property of Govaerts Recycling as long as they remain unpaid. From their due date all unpaid invoices will be increased, by law and without formal notice, by an interest based on the reference interest increased with an additional 7 percentage points and rounded-up to the nearest half a percentage point (art. 5, Act 02/08/2002). In addition, all unpaid invoices will be increased, by law and without formal notice, by a fixed compensation of 10% of the due amount on the invoice, except when the real collection charges - including the costs for legal assistance - should be higher (art. 6, Act 02/08/2002).

4. Govaerts Recycling guarantees the reliability of its delivered goods for a period of 2 years after their delivery. In case a delivery of defect goods should be proven by the Client, Govaerts Recycling will, at its own discretion, either exchange the defect goods, or credit the corresponding invoice.

5. Govaerts Recycling guarantees the durability of its Gopaplast profiles to the Client for a period of 10 years after delivery. This period starts from the date of the invoice of the delivery. The Client bears the obligation to prove the defectiveness of the Gopaplast profile. The guarantee does not cover discolouration or expansion of the products due to the climatological and weather conditions to which Gopaplast profiles are exposed. The guarantee does further not apply to defects caused by normal wear and tear or the conduct of the Client and/or third parties (including incorrect positioning and assembly and improper use). This guarantee does not apply to assembled Gopaplast profiles and sheets, which have their own guarantee provisions. The guarantee obligations of Govaerts Recycling are strictly limited to 4 and 5 above.

6. Notwithstanding its right to compensation for damages, Govaerts Recycling is entitled in case of the Client's failure to pay on a single due date, or failure to fulfill any other contractual obligation, to either postpone the execution of the agreement or to rescind the agreement by law by merely sending a registered letter to that effect.

7. This transaction is governed by Belgian law. In the event of a dispute the courts of law of Tongeren (Belgium) will have exclusive jurisdiction with the understanding that Govaerts Recycling is entitled to pursue the dispute through the courts of law of the Client's registered place of business/domicile.